

Catering

Depth 815 mm

Cabinet Smart 700 lt -18°-22°C 1 door

Model: **A70/1BE**

Code: **A120706001**

Exterior/interior finishing:

- Stainless steel AISI 304 18/10
- Back in galvanised steel

Insulation:

- 75 mm thickness - CFC/HCFC free

Cover evaporator:

- Removable in PVC

Internal racks and slides:

- Stainless steel AISI 304 18/10

Inner corners:

- Rounded corners ensuring maximum hygiene

Feet:

- Stainless steel AISI 304 adjustable 100-150 mm

Door:

- Self-closing, reversible with 105° dwell

Door handle:

- Integrated in PVC

Door gasket:

- Magnetic, easy to replace



Constructional data

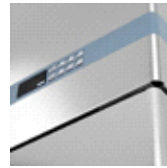
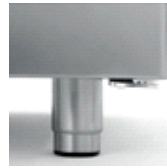

• Dimensions	740×815×2085 mm
• Packing dimensions	760×850×2250 mm
• Net weight	140 Kg
• Gross capacity	700 lt
• Temperature range	-18°-22°C
• Cooling capacity	782 W*
• Standard connection	230 V - 50 Hz
• Total rate	854 W - 4,8 A
• Cooling gas	R404a
• Standard equipment	N. 3 plastic coated shelves - GN2/1 Key lock
• *Evap. -23,3°C cond. 54,4°C	

Features

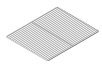

Plastic coated shelf GN 650×530 mm
Code O221650530



Kit of 4 swivel and brake castors in stainless steel AISI 304
Code O444000020



Lighting kit 07
Code O820700020



Pair of slides type C - 605 mm
Code O121160520

Accessories



Cold Line S.r.l. • Via E. Mattei, 38 • 35038 Torreglia • Padova - Italy • www.coldline.it • info@coldline.it

In order to constantly offer the best possible products, we reserve the right to make changes on technical specifications without incurring any obligation for equipment previously or subsequently sold.



Catering

Depth 815 mm

Cabinet Smart 700 lt -18°-22°C 1 door

Coldline made major investments in design research, becoming a leader in technology and innovation. Each cabinet marked with the FSSsymbol is equipped with a refrigeration system independent of the structure, which provides improved flexibility and service.



FSS • FAST SERVICE SYSTEM

- You can change the intended use of an appliance, a freezer into a chiller - and the other way around - even after years of installation.
- You can extend the life of a refrigeration cabinet by replacing its old refrigeration system with a new one.
- Maintenance and service are simple, quick and do not require specialised personnel.

FSS • Fast Service System

NO-COMPROMISE QUALITY STEEL

AISI 304

AISI 304 18/10 is a high quality steel. Its stability guarantees good-looking and durable products, ensuring maximum hygiene and corrosion resistance over time.

75 mm

INSULATION THICKNESS

The 75 mm thick insulation ensures lower heat loss, reduced work of the compressor, therefore lower energy consumption.

INTELLIGENT DEFROST

Intelligent defrost changes according to the actual presence of frost. The system runs for the minimum time required.

EVAPORATION SYSTEM

The automatic evaporation of condensing water is activated only in the presence of water produced as a result of a defrost cycle.

CONSTANT TEMPERATURE

The fans stop when the door is opened to reduce temperature changes and consequently reduce the work of the compressor.

ASPERA COMPRESSORS

Aspera compressors reduce energy consumption by 15% and acoustic impact by 5 dBA.

Focus

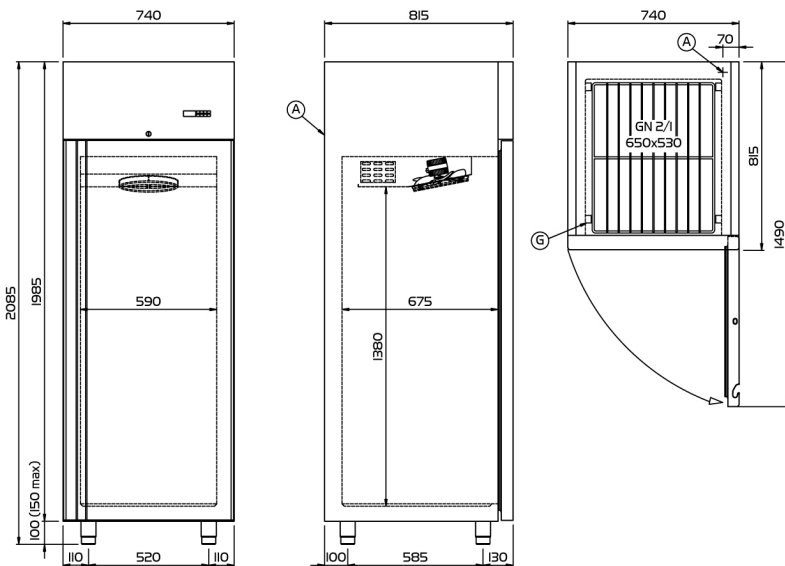

(A) POWER SUPPLY CABLE OUTLET

(G) RACKS PITCH



Technical drawing



Cold Line S.r.l. • Via E. Mattei, 38 • 35038 Torreglia • Padova - Italy • www.coldline.it • info@coldline.it

In order to constantly offer the best possible products, we reserve the right to make changes on technical specifications without incurring any obligation for equipment previously or subsequently sold.



• Trade mark:	Coldline
• Model:	A70/1BE
• Design:	Upright cabinet
• Energy efficiency class :	F
• Energy efficiency index :	90,9
• Net volume positive/negative:	- 435
• Climate class:	4 (30°C-55% r.h.)
• Energy consumption over 24 hours (E24h):	9,00
• Annual energy consumption in kWh:	3285
• Cooling gas:	R404a



ENERG

енергия · ενεργεια

Y
IJA

IE
IA



A70/1BE



ENERGIA · ЕНЕРГИЯ · ΕΝΕΡΓΕΙΑ
ENERGIJA · ENERGY · ENERGIE
ENERGI

3285

kWh/annum



- L



435 L



4

30°C-55%

2015/1094-I

Energy label (UE 2015/1094)

